

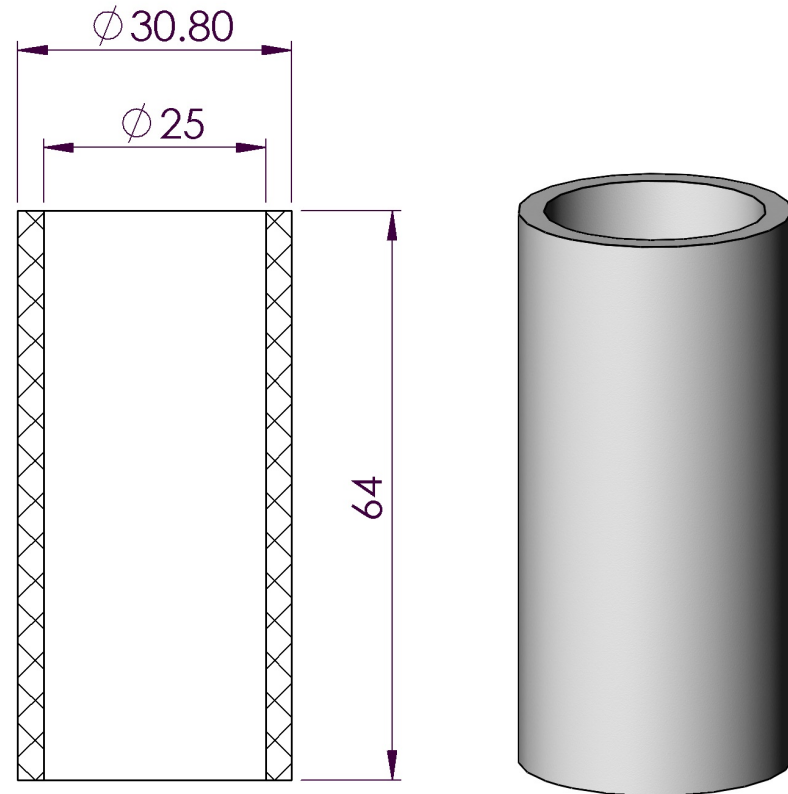

HF Headline Filters

Filter Element: PT-25-64-03

Technical Specification	
Description	PTFE (Teflon) Filter Element
Materials of Construction	100% virgin PTFE Polytetrafluoroethylene
Filtration Efficiency	3 Micron Nominal
Air Flow Resistance	0.9 M ³ /H in air at 25°C
Dimensions	I.D. - 25.00mm ± 0.25mm
	O.D. - 30.80mm ± 1.5mm
	Length - 64.00mm ± 0.25mm
Strength (dry)	Collapse minimum - 10.2 Bar
Temperature Resistance	-150°C to +220°C maximum in air
Chemical Resistance	Resistant to all mineral, vegetable
	And synthetic compressor lubricants.
	Consult chemical resistance chart for Other gases and liquids.



For further specific information please contact our Technical Department
This is a guide only

Headline Filters Limited Mill Hall Business Estate Aylesford Kent, ME20 7JZ www.headlinefilters.com info@headlinefilters.com	Filter Element: PT-25-64-03		THE COPYRIGHT OF THIS DRAWING IS RESERVED BY HEADLINE FILTERS. IT IS ISSUED ON CONDITION THAT IT IS NOT COPIED, REPRODUCED OR DISCLOSED TO A THIRD PARTY EITHER WHOLLY, OR IN PART WITHOUT CONSENT IN WRITING.
	Material: 100% virgin PTFE Polytetrafluoroethylene		
DO NOT SCALE DRAWING IF IN DOUBT ASK			