

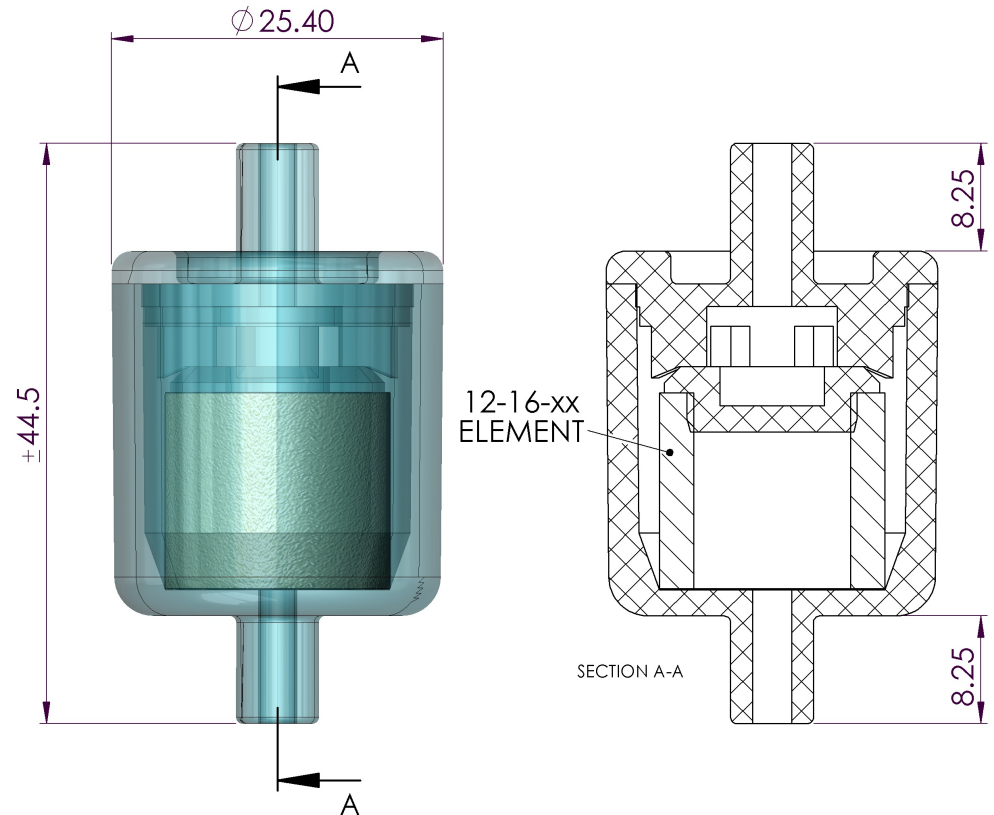

HF **HeadlineFilters**

Part Number: DIF-MN50

Technical Specification	
Description	Disposable In-line Filter
Materials of Construction	Nylon with Borosilicate Glass filter element bonded with fluorocarbon
Filtration Efficiency	Better than 99.99+% removal of 0.1 micron particles
Max Pressure Drop	1 Bar
Dimensions	O.D. - 25.40 ± 1.5mm Length - 44.50 ± 0.25mm
Flow Rate-	Air flow Nm ³ /hr at 0.1 Bar pressure drop 0.1Bar 1Bar 2Bar 4Bar 7Bar 10Bar 0.7 1.3 1.95 3.2 5.0 7.0
Max Temperature	At 0 Bar pressure 110°C
Max Pressure	At 40°C 7 Bar



For further specific information please contact our Technical Department
This is a guide only

Headline Filters Limited Mill Hall Business Estate Aylesford Kent, ME20 7JZ www.headlinefilters.com info@headlinefilters.com	Part Number: DIF-MN50		THE COPYRIGHT OF THIS DRAWING IS RESERVED BY HEADLINE FILTERS. IT IS ISSUED ON CONDITION THAT IT IS NOT COPIED, REPRODUCED OR DISCLOSED TO A THIRD PARTY EITHER WHOLLY, OR IN PART WITHOUT CONSENT IN WRITING.
	Material: Nylon with Borosilicate Glass filter element bonded with fluorocarbon		
DO NOT SCALE DRAWING IF IN DOUBT ASK			